

ISOLAMBOX

CATALOGUE ISOLAM BOX

The ISOLAMBOX catalogue contains various isothermal solutions based on the needs of transport, temperature maintenance and positioning target of the customer's product. In fact, it includes classic EPS systems to more innovative systems for optimizing space, thanks to boxes supplied flat ready for easy and quick assembly, even fully customizable.

It is possible to achieve several results combining the different solutions. Isonova will be able to take care of the development of the Packaging, guiding the customer in choosing the most suitable packaging and, upon specific request, can design a customized packaging.

The amount of refrigerant required may vary depending on the environmental characteristics and content during transport.

The customer is required to carry out the appropriate tests to approve the chosen solution. Upon request as an additional service, Isonova can perform theoretical calculations to simulate the quantity of refrigerant necessary to maintain the required temperature according to the product contained and the expected external temperature.

ISONOVA s.r.l.

Cap. Soc. €200.000,00 i.v. - Sede e Stabilimento: Via Brandizzo,144 - 10088 Volpiano (TO) Italy
tel +39 0119955476 - fax +39 011 9955477 - email: info@isonova.it

www.isonova.it | www.laminil.it | www.ledopack.it

C.F. / P. IVA / TVA / VAT - IT 04425740018 - R.I. Torino 2539/1983 - R.E.A. TO 632256

CODES (in order):

DESCRIPTION: SC (BOX), C (PACK)

MATERIAL CODE: 326 (2mm), 464 (4mm), EPS30 (30mm), EPS38 (308mm), EPS45 (45mm), PP30 (30mm)

MISURES: in mm

MODEL: AM (slotted type), AU (folder type), CO (hinged flap)

ACCESSORIES:

- REFRIGERANTS

ALL ARTICLES IN THE CATALOGUE ARE SUPPLIED IN PACKS: 5 PCS FOR BOXES, 10 PCS FOR COLD FOLD AND REFRIGERANTS AND 50 PCS FOR BAGS.

QUOTED PRICES:

Per pc/kit, IVA, transport excluded (added to invoice)

MINIMUM PURCHASE QUANTITY:

For the first order, it's possible to purchase a pack of 5/10 pieces of isothermal boxes to run the relevant test for project's suitability

From the second order:

ISOLAMBOX: minimum purchase 500 pieces

COLD FOLD: minimum purchase 50 pieces

E-COMMERCE & PHARMA – TRANSPORT UP TO 48H STANDARD COURIER (FRIDGE TEMPERATURE)

FOLDING SYSTEM – CUSTOMIZABLE – HIGH QUALITY

ISOLAMBOX in LAMINIL

THESE LAMINIL BASED BOXES ARE AVAILABLE ONLY IN LAMINIL CODE 464 SILVER PET (EXTERNAL) / KRAFT PAPER (INTERNAL). THICKNESS 4mm: CODE 464
ADDITIONAL KITS FOR SLOTTED-TYPE MODELS WITH 6 WALLS OF 4CM IN EPS TO INCREASE THE DURATION OF THERMAL RESISTANCE UP TO 48H IN COMBINATION WITH SUFFICIENT QUANTITY OF REFRIGERANT.

SLOTTED-TYPE (FEFCO 0204):

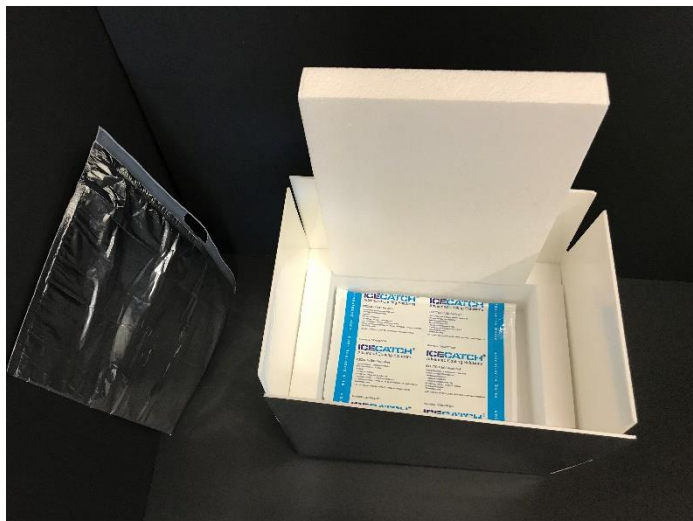
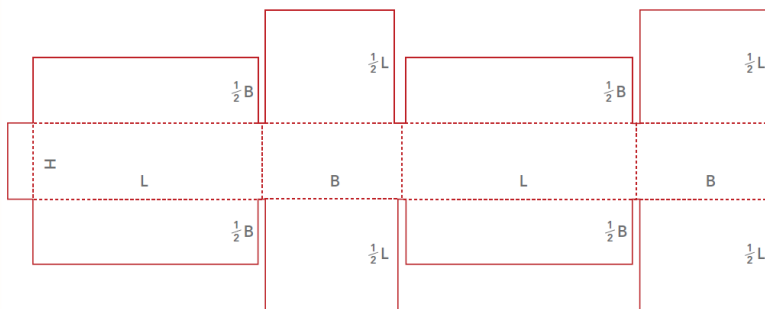

ISONOVA s.r.l.

Cap. Soc. €200.000,00 i.v. - Sede e Stabilimento: Via Brandizzo,144 - 10088 Volpiano (TO) Italy
tel +39 0119955476 - fax +39 011 9955477 - email: info@isonova.it

www.isonova.it | www.laminil.it | www.ledopack.it

C.F. / P. IVA / TVA / VAT - IT 04425740018 - R.I. Torino 2539/1983 - R.E.A. TO 632256

SCC464400300200AM

40X30X20cm (4mm)

PACK OF 5 PCS

PACK DIMENSIONS: 770X760X75mm

SCC464470260300AM

47X26X30cm (4mm)

PACK OF 5 PCS

PACK DIMENSIONS: 770X760X75mm

SCC464450400310AM

45X40X31cm (4mm)

PACK OF 5 PCS

PACK DIMENSIONS: 960x1010x75mm

SCC464600400360AM

60x40x36cm (4mm)

PACK OF 5 PCS

PACK DIMENSIONS: 960x1010x75mm

KIT INTERNAL WALLS

SCKEPS4400300200

ADDITIONAL KIT OF 6 EPS WALLS 4cm THICK FOR IMPROVED THERMAL RESISTANCE (SCA 40x30x20):

PACK OF 5 KIT

PACK DIMENSIONS: 700x1000x150mm (F/C)

SCKEPS4470260300

ADDITIONAL KIT OF 6 EPS WALLS 4cm THICK FOR IMPROVED THERMAL RESISTANCE (SCA 47x26x30):

PACK OF 5 KIT

DIMENSIONI CONFEZIONE: 520x460x470 (AM)

ISONOVA s.r.l.

Cap. Soc. €200.000,00 i.v. - Sede e Stabilimento: Via Brandizzo,144 - 10088 Volpiano (TO) Italy
tel +39 0119955476 - fax +39 011 9955477 - email: info@isonova.it

www.isonova.it | www.laminil.it | www.ledopack.it

C.F. / P. IVA / TVA / VAT - IT 04425740018 - R.I. Torino 2539/1983 - R.E.A. TO 632256

SCKEPS450400310

ADDITIONAL KIT OF 6 EPS WALLS 4cm THICK FOR IMPROVED THERMAL RESISTANCE (SCA 45X40X31):

PACK OF 5 KIT

PACK DIMENSIONS: TBC

SCKEPS4600400360

ADDITIONAL KIT OF 6 EPS WALLS 4cm THICK FOR IMPROVED THERMAL RESISTANCE (SCA 60x40x36):

PACK OF 5 KIT

PACK DIMENSIONS: TBC

E-COMMERCE & PHARMA – TRANSPORT UP TO 48H STANDARD COURIER (AMBIENT TEMPERATURE)

FOLDING SYSTEM – CUSTOMIZABLE – HIGH QUALITY

ISOLAMBOX in LAMINIL

THESE LAMINIL BASED BOXES ARE AVAILABLE ONLY IN LAMINIL CODE 464 SILVER PET (EXTERNAL) / KRAFT PAPER (INTERNAL). THICKNESS 4mm: CODE 464 TO BE USED IN COMBINATION WITH SUFFICIENT QUANTITY OF REFRIGERANT.

SLOTTED-TYPE (FEFCO 0204):

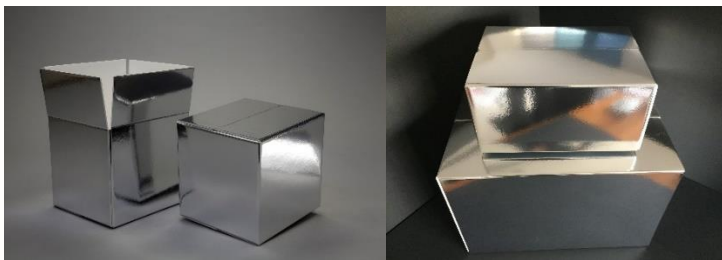
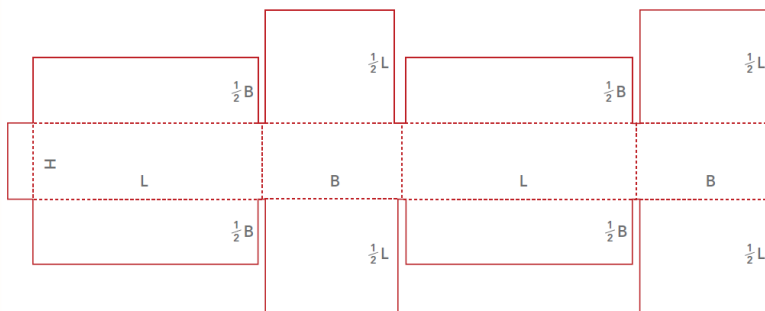

ISONOVA s.r.l.

Cap. Soc. €200.000,00 i.v. - Sede e Stabilimento: Via Brandizzo,144 - 10088 Volpiano (TO) Italy
tel +39 0119955476 - fax +39 011 9955477 - email: info@isonova.it

www.isonova.it | www.laminil.it | www.ledopack.it

C.F. / P. IVA / TVA / VAT - IT 04425740018 - R.I. Torino 2539/1983 - R.E.A. TO 632256

SCC464375225135AM

37,5X22,5X13,5cm (4mm)

5pc PACK

PACK DIMENSIONS: 460x570x60mm

SCC464370200200AM

37x20x20cm (4mm)

5pc PACK

PACK DIMENSIONS: 560x570x60mm



ISONOVA s.r.l.

Cap. Soc. €200.000,00 i.v. - Sede e Stabilimento: Via Brandizzo,144 - 10088 Volpiano (TO) Italy
tel +39 0119955476 - fax +39 011 9955477 - email: info@isonova.it

www.isonova.it | www.laminil.it | www.ledopack.it

C.F. / P. IVA / TVA / VAT - IT 04425740018 - R.I. Torino 2539/1983 - R.E.A. TO 632256

TAKE AWAY – TRANSPORT UP TO 2H

FOLDING SYSTEM – CUSTOMIZABLE – HIGH QUALITY

ISOLAMBOX in LAMINIL

THESE LAMINIL BASED BOXES ARE AVAILABLE ONLY IN CODE 326 IN KRAFT PAPER FINISH. THICKNESS 2mm: CODE 326.

FOLDER-TYPE:

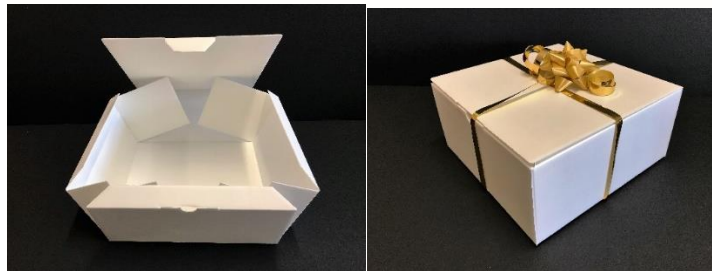
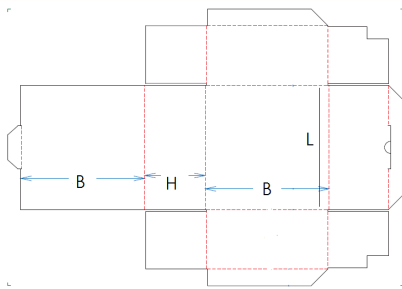

SCC32613013075AU

13x13x7,5cm (2mm)

5pc PACK

PACK DIMENSIONS: TBC

SCC326210210105AU

21x21x10,5cm (2mm)

5pc PACK

PACK DIMENSIONS: TBC

SCC326260260120AU

26x26x12cm (2mm)

5pc PACK

PACK DIMENSIONS: 570x830x22mm

ISONOVA s.r.l.

Cap. Soc. €200.000,00 i.v. - Sede e Stabilimento: Via Brandizzo,144 - 10088 Volpiano (TO) Italy
tel +39 0119955476 - fax +39 011 9955477 - email: info@isonova.it

www.isonova.it | www.laminil.it | www.ledopack.it

C.F. / P. IVA / TVA / VAT - IT 04425740018 - R.I. Torino 2539/1983 - R.E.A. TO 632256

BIO ISOLAMBOX FOLDER TYPE:

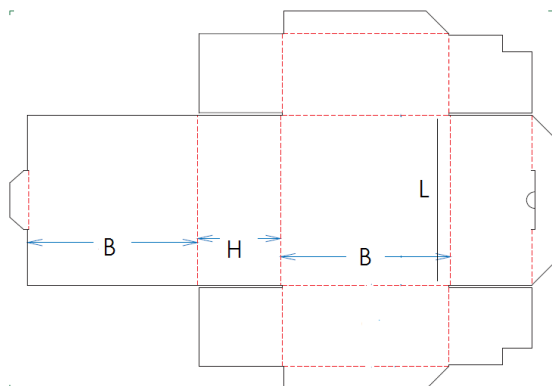

SCCBIO332220165045AU

22x16,5x4,5cm (3mm)

5pc PACK

PACK DIMENSIONS: TBC

Laminil boxes are fully customizable, in terms of size, model, finish and print. For example:



ISONOVA s.r.l.

Cap. Soc. €200.000,00 i.v. - Sede e Stabilimento: Via Brandizzo,144 - 10088 Volpiano (TO) Italy
tel +39 0119955476 - fax +39 011 9955477 - email: info@isonova.it

www.isonova.it | www.laminil.it | www.ledopack.it

C.F. / P. IVA / TVA / VAT - IT 04425740018 - R.I. Torino 2539/1983 - R.E.A. TO 632256

E-COMMERCE & PHARMA – TRANSPORT UP TO 48H STANDARD COURIER (FRIDGE & FREEZER TEMPERATURE)

FOLDABLE SYSTEM – FAST MOUNTING

ColdFold® EPS

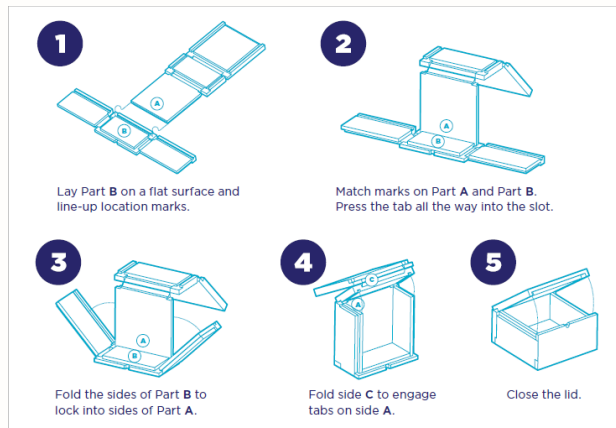

SCACFPSKG3

3Kg (2,8cm)

10pc PACK

PACK DIMENSIONS: 58x58x35cm

SCACFPSKG10

10Kg (3,8cm)

10pc PACK

PACK DIMENSIONS: 40x43x100cm (A) + 31x39x113cm (B)

SCACFPSKG20

20Kg (4,5cm)

10pc PACK

PACK DIMENSIONS: 46x46x116cm (A) + 41x46x121cm (B)

ONLY ON REQUEST:

SCACFPSKG5

5Kg (3cm)

10pc PACK

ISONOVA s.r.l.

Cap. Soc. €200.000,00 i.v. - Sede e Stabilimento: Via Brandizzo,144 - 10088 Volpiano (TO) Italy
tel +39 0119955476 - fax +39 011 9955477 - email: info@isonova.it

www.isonova.it | www.laminil.it | www.ledopack.it

C.F. / P. IVA / TVA / VAT - IT 04425740018 - R.I. Torino 2539/1983 - R.E.A. TO 632256

ONLY ON REQUEST:

ColdFold® EPS 5Kg - RE-USABLE

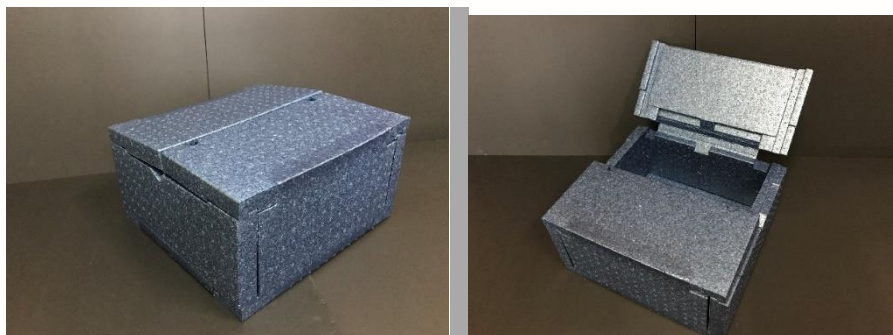

5kg - 1 Piece

ColdFold®
ColdFold XT®

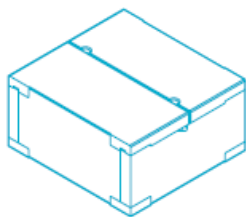
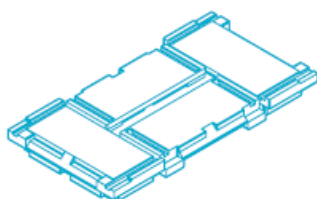

Specifications

External Length	362mm
External Width	340mm
External Height	180mm
Thickness	30mm
Internal Length	302mm
Internal Width	280mm
Internal Height	120mm

SCACFPSKG5
36,2X34X18cm (3cm)

PACK OF 10 PCS
PACK DIMENSIONS: 715x438x284mm

ISONOVA s.r.l.

Cap. Soc. €200.000,00 i.v. - Sede e Stabilimento: Via Brandizzo,144 - 10088 Volpiano (TO) Italy
tel +39 0119955476 - fax +39 011 9955477 - email: info@isonova.it

www.isonova.it | www.laminil.it | www.ledopack.it

C.F. / P. IVA / TVA / VAT - IT 04425740018 - R.I. Torino 2539/1983 - R.E.A. TO 632256

ACCESSORIES

REFRIGERANTS

The refrigerants in this catalogue are suitable for maintaining the temperature from 0°C upwards. For temperatures below 0°C, alternative products are available, not in catalogue



ISONOVA s.r.l.

Cap. Soc. €200.000,00 i.v. - Sede e Stabilimento: Via Brandizzo,144 - 10088 Volpiano (TO) Italy
 tel +39 0119955476 - fax +39 011 9955477 - email: info@isonova.it

www.isonova.it | www.laminil.it | www.ledopack.it

C.F. / P. IVA / TVA / VAT - IT 04425740018 - R.I. Torino 2539/1983 - R.E.A. TO 632256

SPECIAL SALES CONDITIONS

1. Sales Conditions:

The supply taking place under the following agreement will be regulated by the Special and General Sales Conditions, signed by the client and attached to this document.

2. Delivery leadtimes:

21 days from the confirmation of the purchase order by Isonova. However Isonova will aim offer the best date according to the client's request.

3. Validity of price list:

31/12/22.

If, for unpredictable circumstances, raw materials' prices increase, (resins, colorant, packaging, energy) by 5% or more, ISONOVA will review prices, with a notification of 15 days from the implementation of the new price list.

4. Payment conditions:

Payment at order.

5. Credit limit:

€ 0

6. Quantity:

Minimum order: 1 pack (first order); second order to be confirmed

In case of off-set or serigraphic printing, the production tolerance is +/-5%

7. Transport:

The cost of the transport is not included in the price, however, on customer request, separately quoted. The packaging of the pallets is not returnable.

8. Instructions on how to use the material / Storage conditions

We are enclosing to this offer a manual on how to use the material and / or a document on the storage conditions. We kindly ask the customer to read these attachments carefully to be able to understand well the function of our material within the transformation process and its optimum storage conditions. After receiving from the customer, the planning details of a new project, especially if complex from an application point of view, Isonova offers a free of charge telephonic technical support. We kindly ask the customer to supply as much information as possible to allow us to suggest from a technical point of view the relevant options to achieve the best results.

9. Graphic design

For the preparation of the design, the print register tolerance consists of +/- 2mm.

Together with the graphic files, commissioned to ISONOVA from the customer, we will need from the customer a written authorization for the use of the graphic design received.

Before the production, a print draft with technical drawing will be sent to the customer to verify text and colours, the customer will be asked to approve the draft.

In case of 4 colour set designs, after the draft approval, even if ISONOVA will try to achieve the colour target, will not be held responsible for costs due to the incorrect interpretation of the design.

PRODUCT INFORMATION

Laminil is the name of a special material obtained by laminating, on a layer of polystyrene expanded extruded, one sheet on each of its sides of paper. The process, patented by Isonova at global level, does not employ glues of any kind, but uses a heat system. The result is a material of exceptional characteristics, not comparable to any other product available on the market. Today in the LAMINIL range, there are articles laminated with hot melt to achieve new products and meet the ever increasing market requests.

MAIN CHARACTERISTICS

Its structure, at closed cells, is homogenous, with a density of around 40 Kg/m³, showing a uniform finish throughout its surface. Lacking of a "fiber feeling", Laminil can be easily printed and cut in any direction allowing results, which cannot be achieved with traditional materials.

Its lightness, at equal mechanical resistance, corresponds to half of the weight of other similar materials; this makes it ideal for packaging applications and optimizes its transportation costs.

Its thermal insulation power, given by the polystyrene low coefficient of thermal conduction, offers to this material, together with its lightness and its durability a unique advantage for the preservation at constant temperature level of food and pharmaceutical products subject to thermal variations during transportation, even at several degrees below zero.

Its impermeability, characteristic intrinsic in the polystyrene sheet part of Laminil, can be increased by using metalized PET. The boxes made out of this material allow as content standard or dry ice, without the risk of leakages. The maximum temperature, which Laminil can be exposed to, is of around 75°C. Laminil is not compatible with organic solvents.

It is advisable to avoid glue based on organic solvents because they damage the material.

IMPORTANT INFORMATION

The Laminil boxes are packaged flat and should be kept in their original packaging until being used, stored in clean places away from direct sunlight, which can cause "yellowing" of the paper. Do not store outside. The guarantee of ISONOVA's products is of 12 months from the date of despatch, if maintained in their original packaging and if the storing instructions have been respected.

To optimize the thermal resistance of the box it is advisable to close it accurately, avoiding the entry of air. We strongly advise to insulate the box using wrapping around film.

For an optimal thermal performance, it is advisable to utilize refrigerants, such as dry ice, inside the box.

The above instructions will be sent to the customer with each new quotation. In the event that these instructions will not be taken into account by the customer, Isonova will not be liable for any non-compliance derived from the misuse of the material. derivate dall'uso inappropriato del materiale.

ISONOVA s.r.l.

Cap. Soc. €200.000,00 i.v. - Sede e Stabilimento: Via Brandizzo,144 - 10088 Volpiano (TO) Italy
tel +39 0119955476 - fax +39 011 9955477 - email: info@isonova.it

www.isonova.it | www.laminil.it | www.ledopack.it

C.F. / P. IVA / TVA / VAT - IT 04425740018 - R.I. Torino 2539/1983 - R.E.A. TO 632256

GENERAL TERMS AND CONDITIONS OF SALE

INTRODUCTION.**BUYER:** Entity, which buys products from the Supplier**SUPPLIER:** Entity, which supplies products to the Buyer**PRODUCTS:** Goods produced by the Supplier**CONTRACT:** All agreements in place between the Buyer and the Supplier for the sell and purchase of the Products, including these **GENERAL TERMS & CONDITIONS OF SALE.****1) General.**

1.1. The supply is subject to these **CONDITIONS OF SALE.** The application of these Conditions by the Supplier is mentioned in all order confirmations sent by the latter to the Buyer.

1.2. The successful execution of the contract will be considered as tacit acceptance of these conditions, unless the Buyer has not expressly disputed the content in writing, prior to the execution itself.

1.3. Acceptance, expressed or implied, constitute a waiver by the Buyer's application of its own conditions of purchase, and arrangements. Any condition that modifies conflicts with or contradicts these Conditions will be deemed invalid and unenforceable, unless specified otherwise. The Supplier does not recognize verbal agreements or commitments with their officials or representatives: any exceptions to these conditions must be in writing.

1.4. The Supplier reserves the right to modify at any time these Conditions, sending written communication to the Buyer. The order is intended as irrevocable proposal of purchase, while the order must be considered accepted by the Supplier only after the issue of an order confirmation or the execution of the same order.

2) Delivery.

2.1. Unless explicitly agreed otherwise, delivery condition shall be EXW the production facility indicated in the Commercial Agreement(s) (Incoterms 2010).

2.2. The Supplier reserves the right to deliver quantities up to 10% above or below the ordered by the Buyer and to invoice the Buyer accordingly. The Supplier shall deliver the Products on the delivery date as specified in the Supplier's order confirmation or as otherwise explicitly agreed upon. Unless otherwise agreed, delivery will be made in minimum quantities as specified in the offer attached to these Conditions. Any quantity variations may result in extra costs to be reimbursed by the Buyer.

2.3. The terms of delivery of the Products, from the date of acceptance of the order by the Supplier, are agreed each time by the two parties and expressed in the order confirmation.

2.4. If the Buyer fails to accept delivery of Products on the delivery date, the Buyer shall be liable for all costs incurred by the Supplier in handling, transporting, storing and insuring such Products.

2.5. The Buyer has forfeited its right to cancellation unless written notice is given to the Supplier Sales and Marketing Administration before the manufacture has commenced.

3) Price and Payment.

3.1. The Buyer shall pay the purchase price set out in the Commercial Agreement(s) or, in case of application of Clause 3.2 below, in the invoice. All prices are exclusive of value added tax and any other taxes, all of which shall be paid by Buyer. The price, as set out in the Supplier's invoice, is payable in full without any deduction, withholding or set-off for any reason, unless otherwise explicitly agreed.

3.2. The Supplier may vary the prices in accordance with the Indexation agreed in the Commercial Agreement(s). The Supplier also reserves its right to revise prices to reflect change of other costs.

3.3. Unless otherwise specified in the offer attached to these Conditions, the payment of the price or the transport cost, must be paid by the Buyer to the Supplier within 60 (sixty) days from the invoice date, according to the Special Conditions of Sale specified in the attached offer. The invoice is issued by the Supplier at delivery of the Products, according to art. 2.

3.4. If Buyer fails to pay any sum when due to the Supplier, then the Supplier shall be entitled to charge interest on the unpaid amount at a rate of four (4) times the statutory legal interest rate from the due date until payment is made in full plus potential debt recovery cost. Other claims on the Buyer, even if not due, will in such case become immediately payable. If the Supplier has reasonable evidence to conclude that the Buyer is unable to comply with its obligations herein or in the Commercial Agreement(s) or if the Buyer undergoes a change of control, the Supplier may at its discretion cancel any order, demand pre-payment and/or other additional guarantees to safeguard its interests.

3.5. The Supplier shall also be entitled to withhold delivery of the Products as long as payment for any prior delivery remains overdue. The ownership to the Products is suspended until full payment has been received even if such Products are in stock or have been integrated into a new product. This reservation of ownership does not affect the transfer of risk.

4) Warranty.

4.1. The Supplier warrants that the products shall not be Defective, in the meaning set out in Clause 4.2 below. The Supplier makes no other warranties or promises of any kind, whether express or implied. If it has been established that the Products delivered to the Buyer are Defective, the Supplier shall at its absolute discretion either replace, free of charge to the Buyer, or refund to the Buyer any monies paid by the Buyer in respect of the purchase price for such Defective Products. To the extent that such non-conformity or defect is partially caused by any act or omission or neglect by the Buyer. The Supplier's obligations hereunder shall be reduced accordingly. The warranty does not cover damages resulting from the Buyer's storage or use of the products unless such storage and use comply with the Supplier's product data sheets. To the avoidance of doubt, the Buyer is the sole Judge and solely responsible for the Products' suitability for the intended use.

4.2. The Products delivered to the Buyer shall be considered as defective ("Defective") if, and only if, they at the time of delivery is not in conformity with the specifications provided by the Supplier in the order proposal which also specifies the transport and storage conditions as well as the maximum duration of use of the products calculated from the time of manufacture. The warranty period is twelve (12) months from date of manufacture.

4.3. The Buyer's sole and exclusive remedy in respect of the supply of Defective products shall be as set out in this Clause 4.

5) Claims Procedure.

5.1. The Buyer shall inspect the Products without undue delay after delivery in order to discover any Defective Products that can reasonably be discovered at such inspection. The Buyer shall notify the Supplier of any such Defective Products discovered at this inspection immediately and in writing. Moreover, transportation damage or loss or inventory shortages shall be notified to the carrier by registered letter with notice of reception within three (3) days following delivery.

5.2. The Buyer shall carry out its production in such a way as to discover any Defective Products that can reasonably be discovered at the start of production. The Buyer shall without undue delay, and in no case later than 48 hours from the moment the Products are first being used, notify the Supplier in writing of any Product which is discovered to be Defective.

5.3. If the Buyer fails to notify the Supplier within the time limits set out in this Clause 5, the Buyer shall lose its rights under Clause 3.

5.4. Any notice of Defective Products shall contain a description thereof. The Buyer shall within 10 working days after such preliminary notice has been given, submit a complete description of the Defective Products and a sample to the Supplier. If so requested, the Buyer will also provide The Supplier access to its production lines to investigate the cause of the Defective Products. The Supplier shall thereafter, without undue delay and with the Buyer's assistance, examine it and to what extent the Product is Defective.

5.5. No claim enables the Buyer to postpone the payment of due invoices. Any compensation for Defective Products or for any other loss, damage or cost claimed by the Buyer shall never exceed the net purchase price of the Defective Products, excluding freight cost, which have been used in the Buyer's production.

6) Consequential Losses.

6.1. The Supplier will not be liable for any indirect, special, punitive, or incidental damages including but not limited to loss of profit, loss of revenue, production or operating losses, lost sales or contracts or damages or penalties, loss of opportunity, loss of good will, or losses relating to marketing activity arising out of or relating to these Conditions even if the Supplier has knowledge of the possibility of any such damages whether contractual or non-contractual.

7) Termination.

7.1. In the event of a failure of the Buyer to comply with its obligations which has not been rectified within 30 days from the Supplier's notice indicating the breach, the Supplier reserves its right to terminate the order without prejudice to any claims that might be presented.

7.2. In the event of continuative contracts, each party has the right to terminate the contract by written notice, at least 30 (thirty) days before the termination date.

7.3. Terminated the contract, as per art. 6, remain the rights and obligations of these Conditions deriving from the acceptance of the orders according to art. 1, before the actual termination.

8) Confidentiality.

8.1. The terms of a separate agreement between the Supplier and the Buyer for confidentiality and/or restricted use of confidential information shall also apply to any information exchanged, in any form in connection with the supply of Products and the duration of that agreement is hereby extended for as long as such information remains confidential.

8.2. All documents forwarded to the Buyer containing, in particular, plans, technical characteristics or test results and any other information which is confidential or proprietary to the Supplier including, without limitation, business, financial or technical information, shall also constitute confidential information.

The Buyer shall return immediately any and all materials received from the Supplier containing confidential information, and all copies thereof in its possession or control, upon the Supplier's written request.

9) Intellectual Property Rights.

9.1. The Buyer expressly releases the Supplier from any liability for and agrees to indemnify and hold harmless the Supplier, its subsidiaries and sub-suppliers against all actions, claims or damages which may be caused by or result from the use of the designs, trade names, trademarks (save for the Supplier's trademarks) colours, patterns, or wording printed on the Products ordered by the Buyer.

9.2. Both parties undertake not to claim ownership to any trademarks, industrial designs or any other intellectual property rights or parts thereof of the other party, either by application or use.

10) Force Majeure.

10.1. Either party will be entitled to suspend performance hereunder (except for any obligation to pay a sum of money) to the extent that such performance is impeded or made unreasonably onerous by any circumstance beyond its reasonable control including but not limited to industrial disputes, fire, war (whether declared or undeclared), terrorism, epidemics, severe weather, volcanic eruptions, flood, extensive military mobilization, insurrection, mass protests, requisition, seizure, embargo, export control regulations, governmental or judicial acts, restrictions in the use of power and defects and delays in deliveries by sub-contractors claiming force majeure. A party invoking this provision shall notify the other party as soon as practicable of the circumstances affecting it and will take reasonable steps to mitigate their length and effect. If this provision is invoked for more than three consecutive months, either party may terminate all such non-performed obligations which are subject to suspension upon written notice to the other party.

11) Severability.

If any provision herein is found to be illegal, invalid or unenforceable by operation of law or otherwise such part will be adjusted:

- (i). only to such extent that it will no longer be found to be illegal, invalid or unenforceable; and
- (ii). to give effect to the original intent of the parties to the maximum extent possible; and
- (iii). in such a way as to ensure that all other provisions of these Conditions will not be affected and remain in full force and effect.

12) Governing Law and Jurisdiction.

12.1. Except as otherwise set forth in a signed agreement between the parties, the present Conditions and the Commercial Agreement(s) relating to it are governed by the substantive laws of the country where the principal place of business of the Supplier company acting as seller under these Conditions is located and the courts of that country shall have exclusive jurisdiction over any dispute arising hereunder and over any non-contractual or other obligations arising out of or in connection with the transactions governed hereunder. The 1980 Vienna Convention on the International Sale of Goods does not apply.